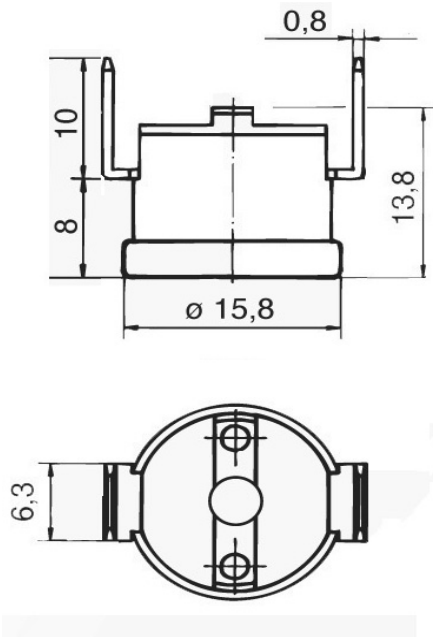

**TERMOSTATO BIMETALICO
LIMITADOR TY 60 FIJO 55°C.**
CÓDIGO CAET: 01.20.0123

Termostato limitador a disco bimetalico a apertura rápida del contacto.	
Fijo	55°C
Tensión y corriente nominal	10A/250V~ 16A/250V~
Corriente mínima	200 mA
Temperatura máxima	T210
Aprobado VDE (DIN EN 60730)	100.000 (10A/250V~) 30.000 (16A/250V~)
nº ciclos	100.000 T180 (13,5A/250V~)
Peso	4,5 gr. Aprox.

FIJACION "D"
