

**TERMOSTATO BIMETALICO  
REGULABLE TY 23 E 0/240°C.**
**CÓDIGO CAET: 01.10.0039**

Termostato unipolar a ruptura brusca del contacto.	
Campo de regulación	0/240°C
Tolerancia temperatura maxima	± 10K ÷ ± 15K
Tensión y corriente nominal	10A/250V~
Corriente mínima	200 mA
Temperatura máxima	T300
Aprobado VDE (DIN EN 60730)	100.000
numero de ciclos	
Peso	22 gr. Aprox.

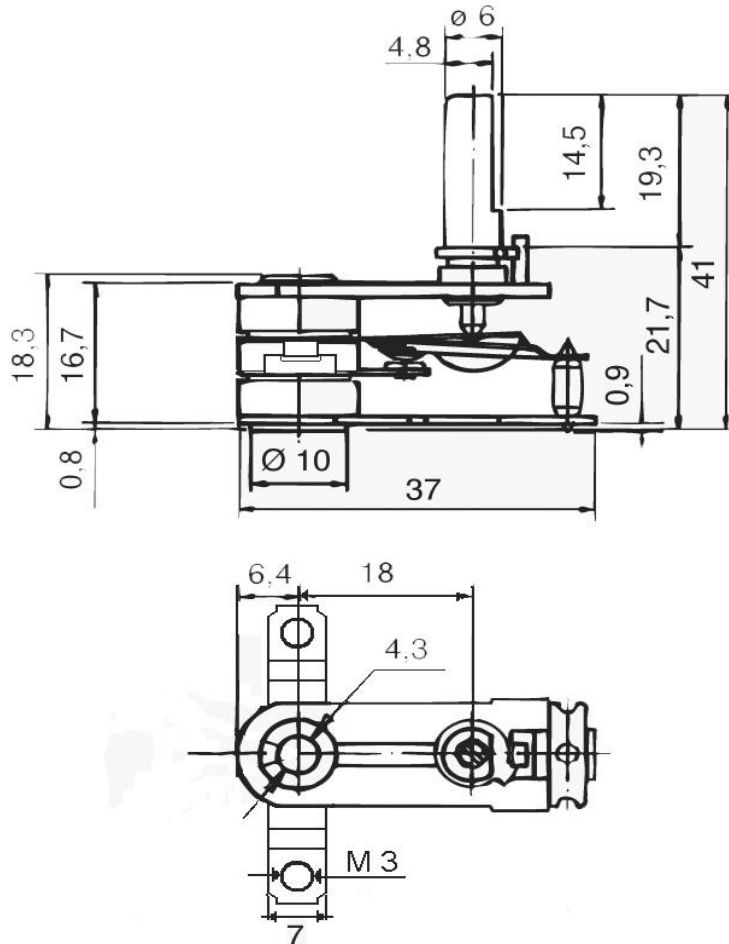